

Request No: Date:

Company Name:

Contact Name:

Alunet Sales Rep:

OPENING DIMENSIONS:

Frame height:

H: mm

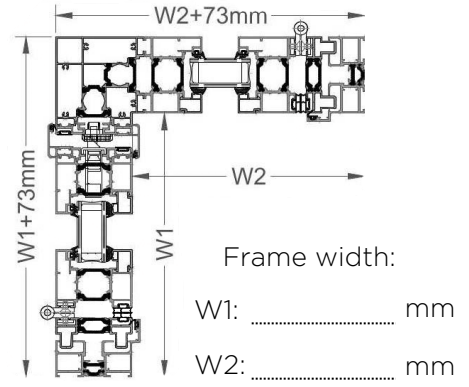

TRACK OPTIONS (circle option)

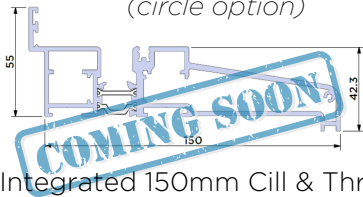

Integrated 150mm Cill & Threshold
BF73.0103 & BF73.0111

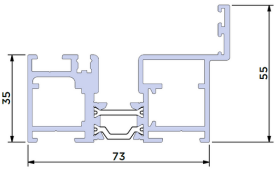

Standard Threshold
BF73.0101

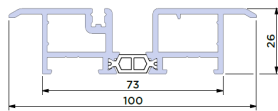

Low Threshold with
Ramp BF73.0204

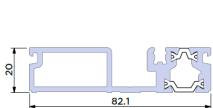

Low Threshold
BF73.0103

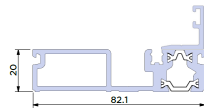

Low Threshold
BF73.0103 &
BF73.0806

SUB CILL OPTIONS (circle option)

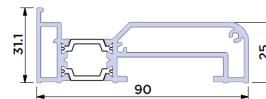

90mm Cill BF73.0402

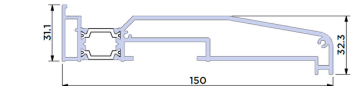

150mm Cill BF73.0405



190mm Cill BF73.0403

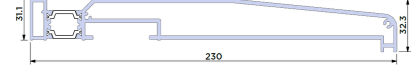

230mm Cill BF73.0404

No Cill

JAMB OPTIONS (circle option)

Adjustable Jamb

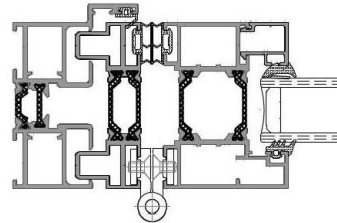

Standard Jamb

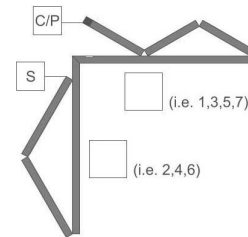
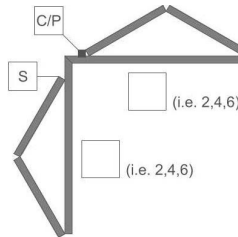
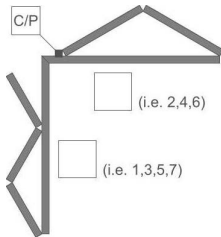
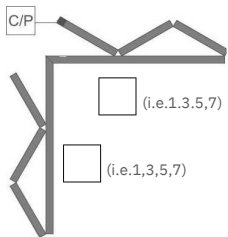
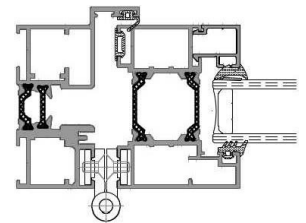

OPENING:
(circle option)

IN OUT

C/P - Corner post position

S Sliding post
Half roller

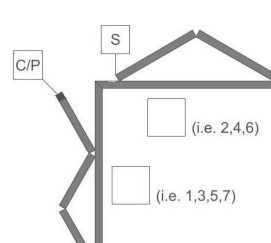
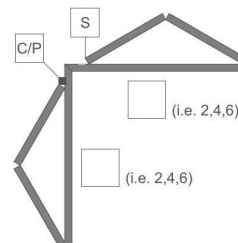
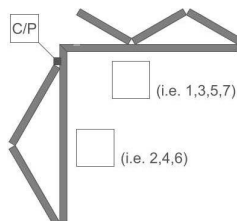
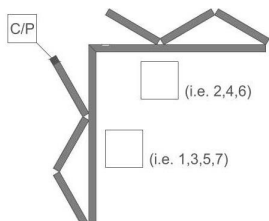

NOTES